

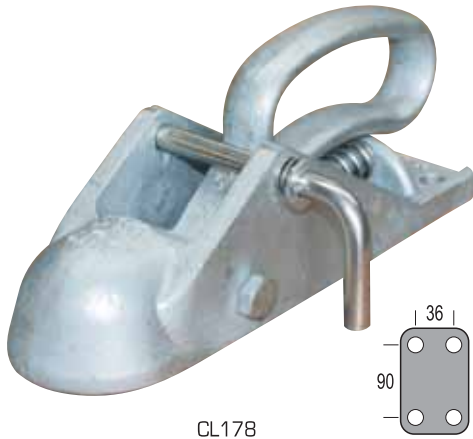

Trailer Couplings



CL178



CFA178



CFR17850



CPR178-2

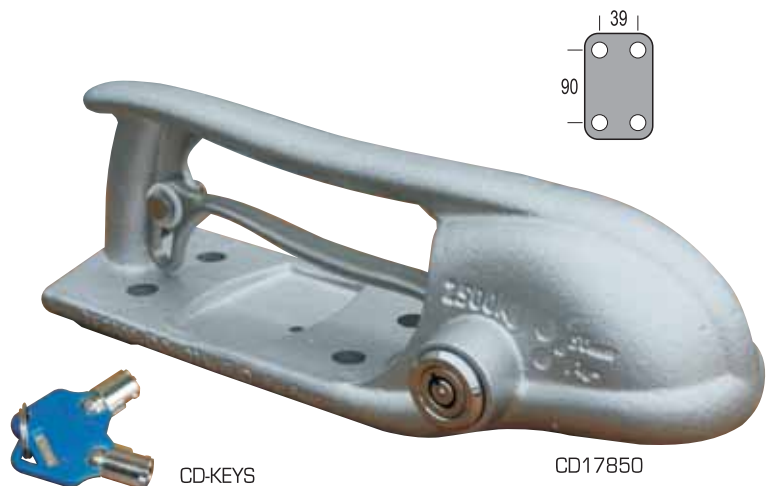

CD-KEYS

CD17850

CODE	SUIT BALL DIAMETER	DESCRIPTION	KG
LEVER TYPE - ZINC PLATED			
CL178	1 ⁷ / ₈ "	Overcentre lever, strong and robust.	2000kg
CL50	50mm	Overcentre lever, strong and robust.	2000kg
MULTI-FIT TYPE - ZINC PLATED			
CD17850	1 ⁷ / ₈ " or 50mm	Will automatically engage 50mm & 1 ⁷ / ₈ " tow balls. Complete with keys.	2500kg
FABRICATED TYPE - ZINC PLATED, MILD STEEL CONSTRUCTED			
CFA178	1 ⁷ / ₈ "	Agricultural Use - Open top prevents mud build up in ball area.	2000kg
CFR17850	1 ⁷ / ₈ " or 50mm	Road Use - Dual Size	2000kg
PRESSED STEEL - ZINC PLATED			
CPR178-2	1 ⁷ / ₈ "	Agricultural & Road Use Suits 2" wide drawbar	910kg
CPR178-25	1 ⁷ / ₈ "	Agricultural & Road Use Suits 2 ¹ / ₂ " wide drawbar	910kg



Trailer Couplings

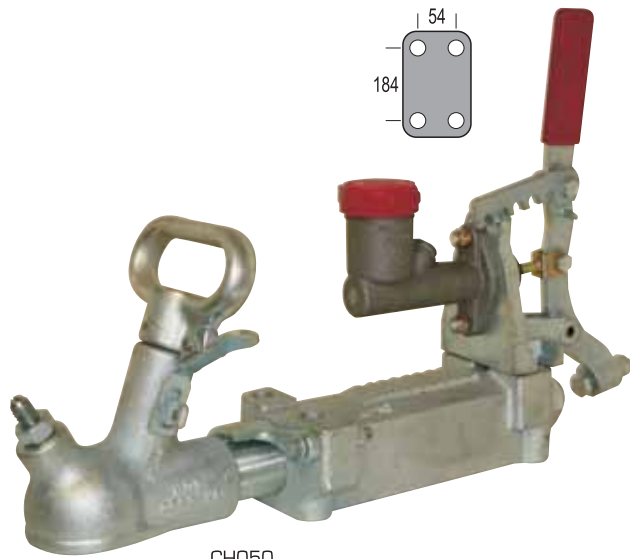

CH050

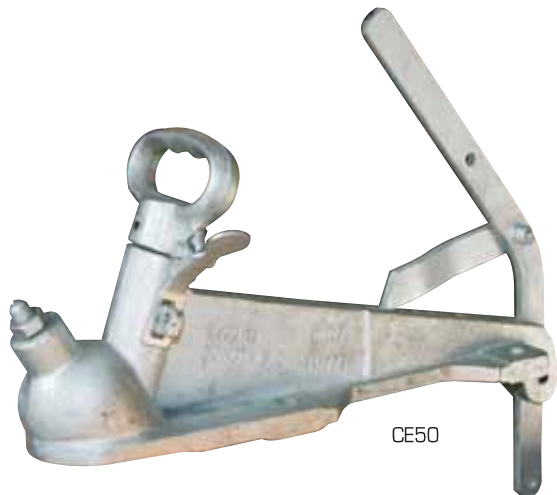

CE50

CODE	SUIT BALL DIAMETER	DESCRIPTION	 KG
HYDRAULIC OVERRIDE - ZINC PLATED			
CH050	50mm	Quick release, includes hand brake assembly, master cylinder. Padlock facility and grease nipples for main shaft lubrication.	2500kg
CH0178	1 7/8"	Quick release, includes hand brake assembly, master cylinder. Padlock facility and grease nipples for main shaft lubrication.	2500kg
MECHANICAL OVERRIDE - ZINC PLATED			
CM050	50mm	Quick release, adjustable screw, base plate and hand brake assembly.	2500kg
ELECTRIC - ZINC PLATED			
CE50	50mm	Quick release, includes handbrake attachment.	3500kg

Coupling Spares

CHO-MCASH
3/4" Master Cylinder
Handbrake assembly



MC-CAP34
Master Cylinder Cap



CL-LPK
Lock Pin Kit
Suits CL178/50









Tow Balls

- All tow balls certified to New Zealand standard.
- Chrome plated.



CODE	 Ball Diameter			
TB17834	1 7/8"	3/4"	45mm	2000kg
TB1783465	1 7/8"	3/4"	65mm	2000kg
TB17878	1 7/8"	7/8"	50mm	3500kg
TB1781	1 7/8"	1"	65mm	3500kg
TB5034	50mm	3/4"	45mm	2000kg
TB5078	50mm	7/8"	50mm	3500kg
TB501	50mm	1"	65mm	3500kg

Tow Bar Accessories

TOWBALL COVER

- Fits 1 7/8" x 50mm



TB-COVER

SAFETY CHAIN & SHACKLE

- Rated to 2000KG



S-CHAIN

SAFETY CHAIN ATTACHMENT

- Cast Stainless Steel



SCA

SHIN PROTECTOR



SHIN-P

D-SHACKLES

- 8mm and 10mm



DS10

DS8

COUPLING LOCK

- Complete with keys



CP-LOCK



CODE	DESCRIPTION
ANTI-LUCE FASTENERS	
ALW13	Anti-luce weld-on 13mm x 12mm shank
ALW50	Anti-luce weld-on 50mm x 12mm shank
ALT20-M8	Anti-luce Threaded 20mm x M8
ALT25	Anti-luce Threaded 25mm x M12
ALT50	Anti-luce threaded 50mm x M12
ALI10	Anti-luce Internal Thread M10
ALB	Anti-luce Bolt On
EYE PLATES	
EP75	Anti-luce Eye Plate 75mm
EP150	Anti-luce Eye Plate 150mm
SPRING BOLTS / LASHING RING	
SP-Bolt-12	Spring Bolt, 12mm Pin x 28mm Throw.
SP-Bolt-16	Spring Bolt, 16mm Pin x 32mm Throw.
LR750	Lashing ring, 750kg, 125L x 115W
LINCH PIN / R-CLIPS	
Linch-6	Linch Pin 6.0mm
R-Clip-3	R-Clip 3.0mm
R-Clip-4	R-Clip 4.0mm
HINGES	
TH305-12	Strap Hinge & Pin 305mm x 40mm Strap x 12mm Pin
TH305-16	Strap Hinge & Pin 305mm x 50mm Strap x 16mm Pin

LR750



Linch Pin



SP-BOLT-16



R-Clips





Hub & Stub Sets

UNBRAKED

- All sets include studded hubs, nuts, dustcaps, bearings, seals and stub axles.
- When ordering a Hub & Stub Set, select the P.C.D. [pitch circle diameter] from the chart at the bottom of the page and add it to the code eg: HS1500 - 5 x 4 1/2

CODE	FINISH	SEALS	STUB AXLE	KG
UNBRAKED				
HS1500	Galvanised	Marine	39mm round	1500kg
HS1750	Galvanised	Marine	45mm round	1750kg



P.C.D. Information

CODE	MAKE	NO. OF STUDS	STUD DIAMETER	P.C.D. (Pitch Circle Diameter)	Distance Between Stud Centres
4 x 4	Mini	4	7/16"	4" (101.5mm)	72mm
4 x 4 1/4	Cortina	4	7/16"	4 1/4" (108mm)	75mm
4 x 4 1/2	Datsun/Toyota	4	7/16"	4 1/2" (114mm)	81mm
5 x 4 15/64	Holden HT	5	7/16"	4 15/64" (107.5mm)	63mm
5 x 4 3/4	Holden HQ	5	7/16"	4 3/4" (120.5mm)	71mm
5 x 4 25/32	Commodore	5	7/16"	4 25/32" (120mm)	71mm
5 x 4 1/2	Ford Falcon	5	1/2"	4 1/2" (114mm)	67mm
6 x 5 1/2	Landcruiser/Nissan	6	1/2"	5 1/2" (140mm)	70mm

NB: Blank Hubs also available [undrilled].



BRAKED

- All sets include studded hubs, nuts, dustcaps, bearings, seals and stub axles.
- When ordering a Hub & Stub Set, select the P.C.D. (pitch circle diameter) from the chart on the opposite page and add it to the code eg: HSDH1500 - 5 x 4 1/2

CODE	CALIPERS & PADS	SEALS	STUB AXLE	
DISC BRAKE - hydraulic				
HSDH1500	Hydraulic Dacromet calipers 260mm x 14mm rotors. Complete with brake pads & NSK Bearings	Marine	39mm round	1500kg
HSDH1500-SS	Hydraulic stainless steel calipers 260mm x 14mm rotors. Complete with brake pads and NSK bearings.	Marine	39mm round	1500kg
HSDH1750	Hydraulic Dacromet calipers 260mm x 14mm rotors. Complete with brake pads & NSK Bearings	Marine	45mm round	1750kg
HSDH1750-SS	Hydraulic stainless steel calipers 260mm x 14mm rotors. Complete with brake pads and NSK bearings.	Marine	45mm round	1750kg
* mechanical calipers available				

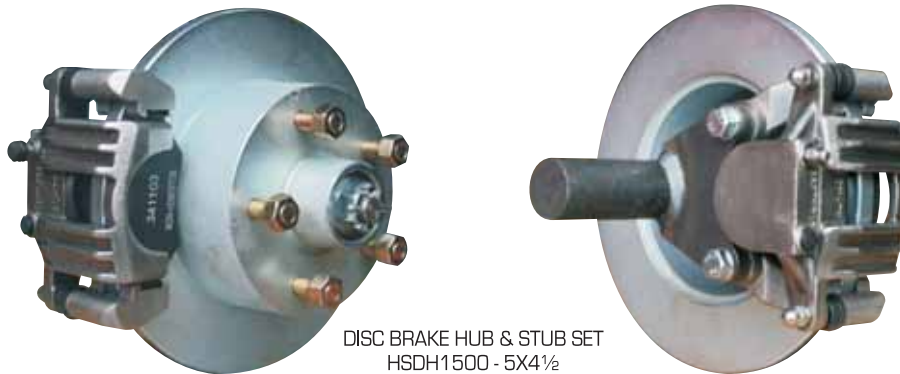

DISC BRAKE HUB & STUB SET
HSDH1500 - 5X4 1/2

CODE	DRUM DIMENSIONS	SEALS	STUB AXLE	
DRUM BRAKE - hydraulic				
HSDR1500	225mm Drum	Marine	39mm round	1500kg
* electrical drum available				



DRUM BRAKE HUB & STUB SET
HSDR1500 - 5X4 1/2



Brake Hose & Fitting Kit

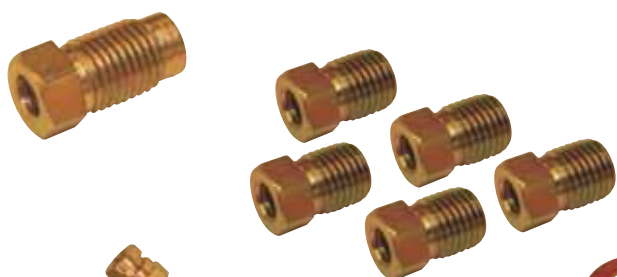

DISC - FLEXI HOSE KIT

CODE	DESCRIPTION
DISC - Flexi Hose Kit	
FH-Disc	Includes - 2x Flexi Hose $\frac{3}{8}$ " UNF 5x Short Tube Nut, 1x Long Tube Nut 1x Tee Piece, 2x Brake Hose Plate and Clip 2x Copper Washer
DRUM - Flexi Hose Kit	
FH-Drum	Included - 1x Flexi Hose $\frac{3}{8}$ " UNF 5x Short Tube Nut, 1x Long Tube Nut 1x Tee Piece, 1x Brake Hose Plate and Clip

Bundy Tubing

BTC15

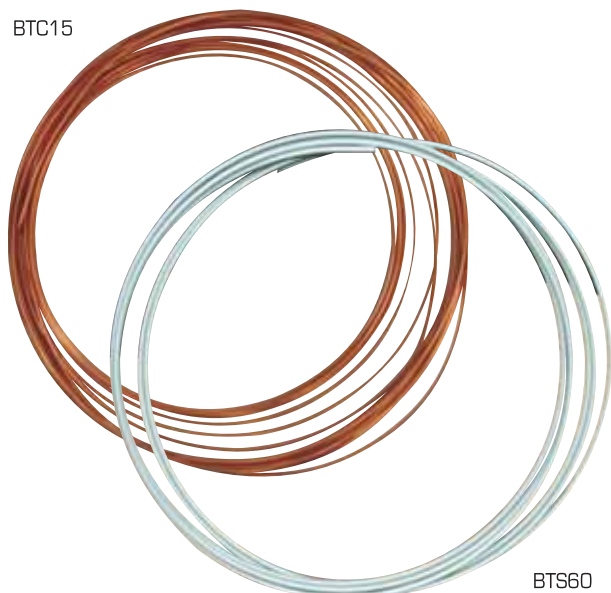

BTS60

CODE	DESCRIPTION
COPPER 3/16"	
BTC75	7.5 metres
BTC15	15 metres
STEEL 3/16"	
BTS60	6.0 metres



Hub & Stub Accessories



STUD12



NUT12



DCAP45

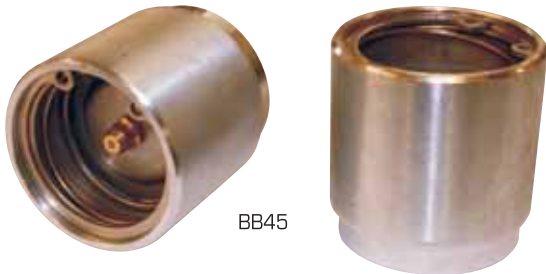

BB45



MS1500

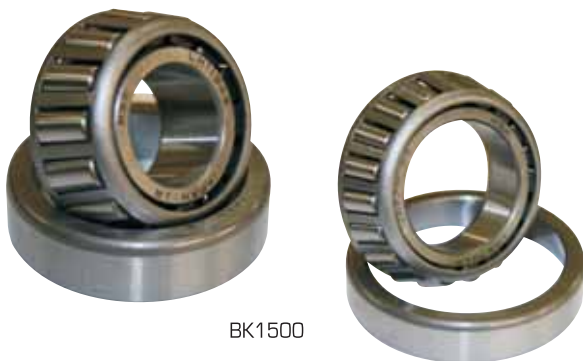

BK1500

CODE	STUDS 45mm length x 4mm spline
STUD 716	7/16" UNF
STUD12	1/2" UNF
NUTS	
NUT 716	7/16" UNF
NUT12	1/2" UNF

CODE	DUST CAP
DCAP45	45mm

CODE	BEARING BUDDIES
BB45	45mm

CODE	HUB SEALS Marine Triple Lip
MS1500	37mm ID x 59mm OD (Suits 1500kg set)
MS1750	43mm ID x 59mm OD (Suits 1750kg set)

CODE	BEARING KITS Includes Marine Seal
BK1500	Outer - LM11949/10 Inner - LM67048/10
BK1750	Outer - LM12749/10 Inner - LM68149/10

- All spring sets are supplied complete with galvanised 'U' Bolts, Fish Plates, Axle Saddles, Slippers/Hangers etc.
- Zinctech finish available in multi leaf short and parabolic springs.

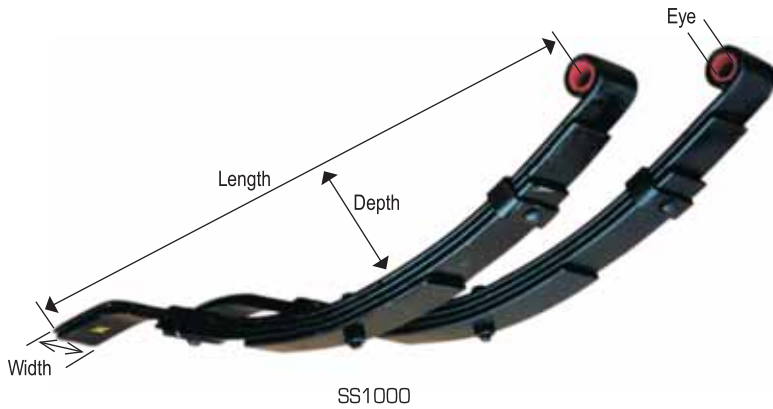

CODE	TYPE	NO OF LEAVES	 PER PAIR
SHORT SPRINGS			
Multi Leaf - painted		610mm(L) x 50mm(W) x 110mm(D) x 16mm(E)	
SS500	multi leaf	2 leaf	500kg
SS750	multi leaf	3 leaf	750kg
SS1000	multi leaf	4 leaf	1000kg
SS1250	multi leaf	5 leaf	1250kg
SS1500	multi leaf	6 leaf	1500kg
SS2000	multi leaf	8 leaf	2000kg
Multi Leaf - Zinctech		610mm(L) x 50mm(W) x 110mm(D) x 16mm(E)	
SS500-Z	multi leaf	2 leaf	500kg
SS750-Z	multi leaf	3 leaf	750kg
SS1000-Z	multi leaf	4 leaf	1000kg
SS1250-Z	multi leaf	5 leaf	1250kg
SS1500-Z	multi leaf	6 leaf	1500kg
SS2000-Z	multi leaf	8 leaf	2000kg
LONG SPRINGS			
Multi Leaf - painted		770mm(L) x 45mm(W) x 160mm(D) x 12.7mm(E)	
SL600	multi leaf	3 leaf	600kg
SL1000	multi leaf	5 leaf	1000kg
SL1350	multi leaf	7 leaf	1350kg
Parabolic - Zinctech		750mm(L) x 45mm(W) x 160mm(D) x 12.7mm(E)	
SP600	single leaf	1 leaf	600kg
SP1000	single leaf	1 leaf	1000kg
SP1400	single leaf	1 leaf	1400kg



Tandem Spring Sets

- All spring sets are supplied complete with Galvanised 'U' Bolts, Fish Plates, Axle Saddles, Slippers/Hangers etc.

CODE	TYPE	NO OF LEAVES	 PER SET (4 springs)
TANDEM SPRINGS - Oscillating Rocker			
STR2000	eye-to-eye	4 leaf	2,000kg
STR3000	eye-to-eye	6 leaf	3,000kg
STR4000	eye-to-eye	8 leaf	4,000kg



CODE	TYPE	NO OF LEAVES	 PER SET (4 springs)
TANDEM SPRINGS - Equalising Rocker			
STE2000	eye slipper	4 leaf	2,000kg
STE2500	eye slipper	5 leaf	2,500kg
STE3000	eye slipper	6 leaf	3,000kg

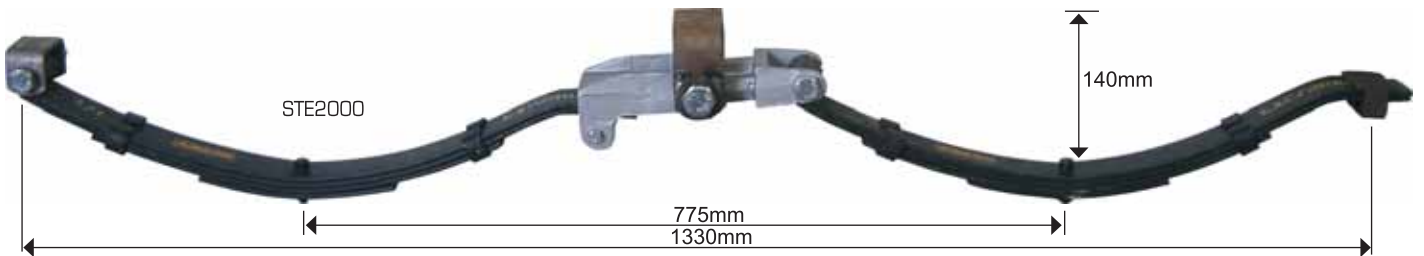

Spring Spares



Hangers & Slippers



Fish Plates



Eye Bolts

CODE	DESCRIPTION
SS45	Slipper - 45mm
SS50	Slipper - 50mm
SH45	Hanger - 45mm, 1/2" eye
SH50	Hanger - 50mm, 16mm eye
F-Plate	Fish plate 110 x 100 x 10mm (hole centres 60 x 60mm)
EB-M12	Eye bolt - M12 x 75 - HT
EB-M16	Eye bolt - M16 x 90 - HT
ENB1912	Eye nylon bush 3/4" x 1/2" x 45mm
ENB2212	Eye nylon bush 7/8" x 1/2" x 45mm
ENB2216	Eye nylon bush 7/8" x 5/8" x 50mm



Eye Nylon Bush



U-Bolts

NB For U-Bolts see page 51



Lights

- A popular and economical lighting option with in-built reflector.
- All ADR approved.



T-LIGHT



TL-SUB



SM-AMBER



SM-RM



SM-CLEAR



LP-LIGHT



REF-84032

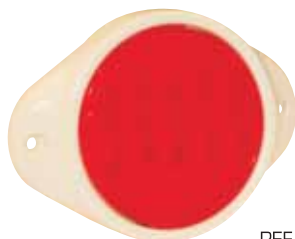

REF-84082

CODE	DESCRIPTION
TAIL LIGHTS	
T-LIGHT	Combination - stop / tail / indicator with licence plate option, 12 Volt, 107L x 107W x 42 H
TL-SUB	Premier Submersible light, 12 Volt, 220L x 110W x 70 H
TL-SUB-LP	As above - includes licence plate lamp.
SIDE MARKERS	
SM-AMBER	Amber lens 12 Volt, 70L x 43W x 33H
SM-AMBER/RED	Amber / Red lens 12 Volt, 70L x 43W x 33H
SM-CLEAR	Round clear lense, Forward facing 12 Volt, 77Dia x 44H
SM-RM	Rubber mounted - Amber / Red 12 Volt, 88L x 56W x 68H
LICENCE PLATE LIGHT	
LP-LIGHT	Licence Plate Light 12 Volt, 107L x 42W x 37H

Reflectors

CODE	DESCRIPTION
REFLECTORS	
REF-84032	90 x 40mm with dual fixing holes
REF-84082	80 diameter with dual fixing holes